

## 8 CHECK LED STATUS

Turn your machine ON and check the LEDs status

Full LED status information on [www.pinsound.org/support](http://www.pinsound.org/support)

### MotionControl

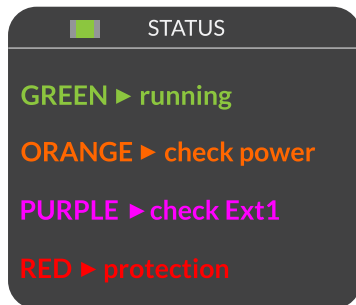

### MasterEffect

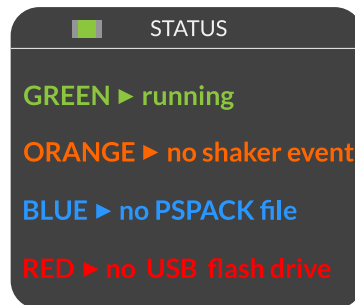

## 9 IF NEEDED: UPDATE THE MASTER EFFECT

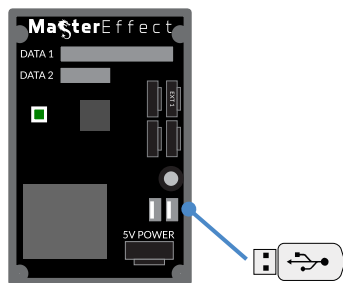

**1** Update the firmware of your Master Effect board  
[www.pinsound.org/support](http://www.pinsound.org/support)

**2** Download and copy the PSPACK Original file at the root of the flash drive  
[www.pinsound.org/machine](http://www.pinsound.org/machine)

## 10 ENJOY!

Have fun with your new shaker!

## NEED HELP?

Installation video  
Firmware update  
Guide  
Q&A

[www.pinsound.org/support](http://www.pinsound.org/support)



# PinSound MotionControl MasterEffect



## Standalone shaker kit for Data-East

### KIT CONTENT

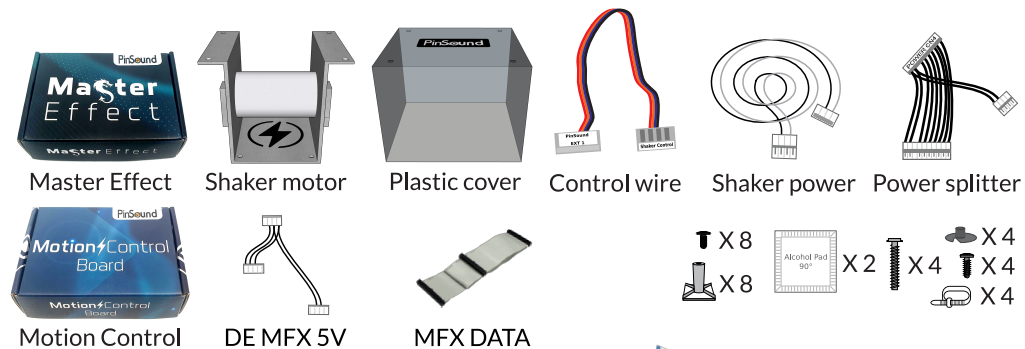

### TOOLS

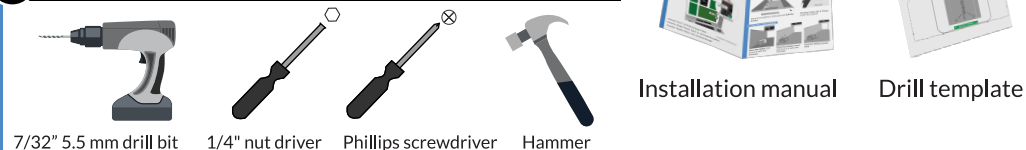

### 1 LOCATE THE CORRECT SPOT

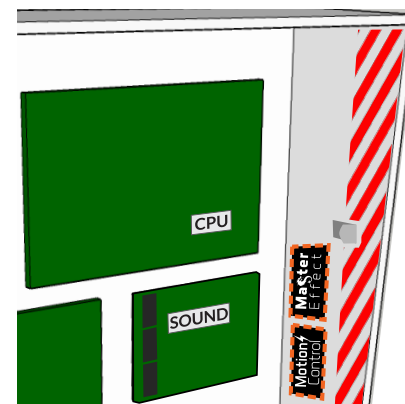

In order for the backbox to close, the 2 boards have to be placed behind the metal hook

### 2 CLEAN THE AREA

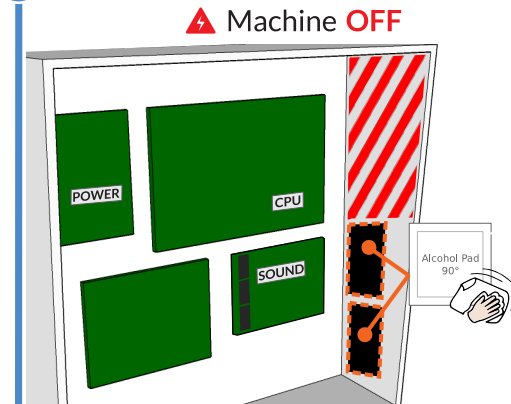

The Motion Control & Master Effect boards will be installed on the right inner side of the backbox

### 3 MOUNT ADHESIVE FEET

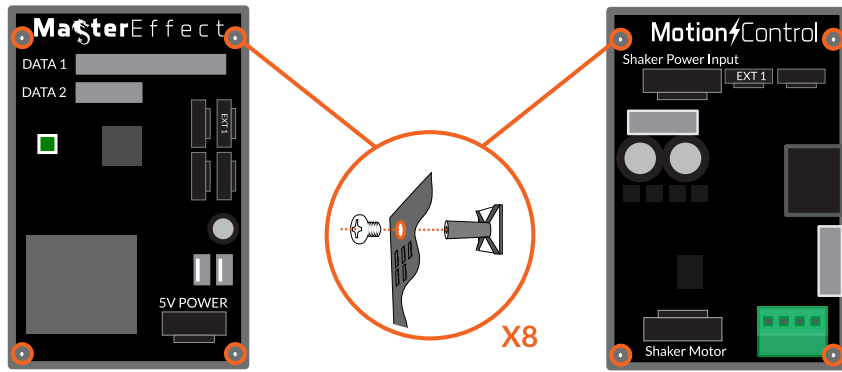

### 4 STICK THE BOARDS & CONNECT

- > Connect **EXT1** from Master Effect to Motion Control
- > Connect **CN4** splitter to **SHAKER POWER INPUT**
- > Connect **SHAKER MOTOR** wire and lay it down to the cabinet
- > Connect **CN2** splitter to **5V DC POWER**
- > Connect **MFx DATA** from **SOUND** to **DATA 2**

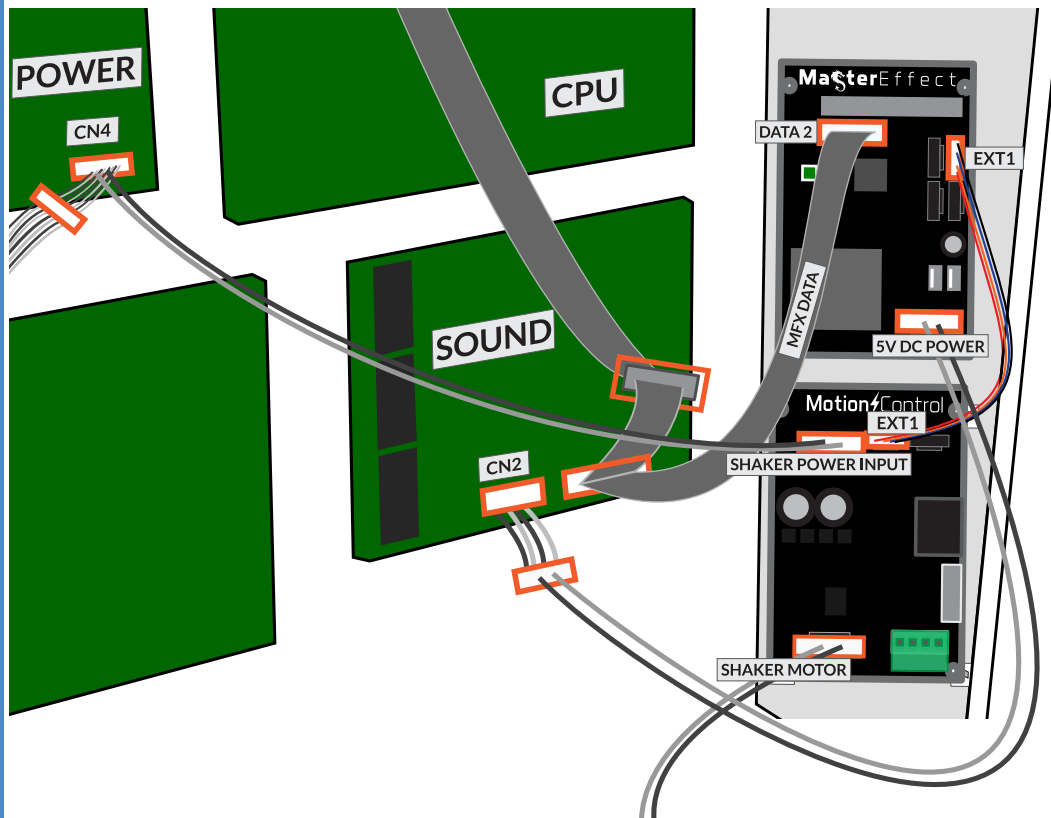

### 5 PREPARE THE DRILL AND THE TEMPLATE

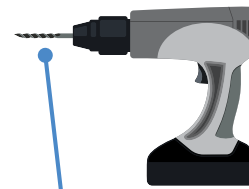

7/32" (5.5mm) drill bit

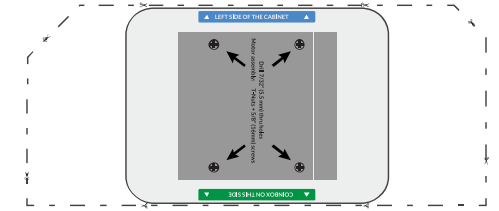

Cut off the Data-East drill template

### 6 PREPARE THE SHAKER FITTING

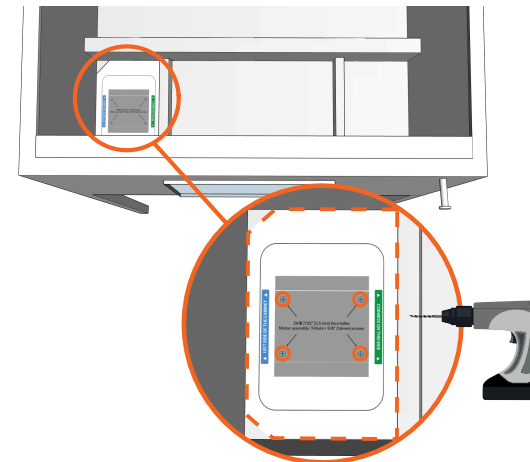

Place the template as indicated and drill the 4 holes

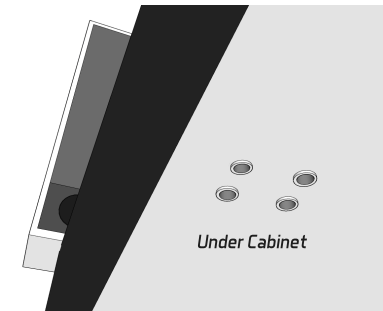

Hammer down the 4 T-Nuts under the cabinet

### 7 INSTALL THE SHAKER

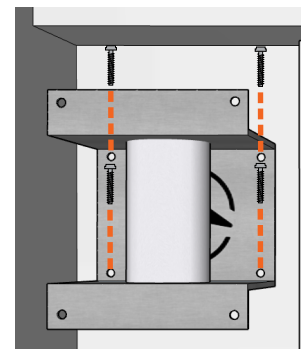

Place the shaker and secure it with the 4 screws

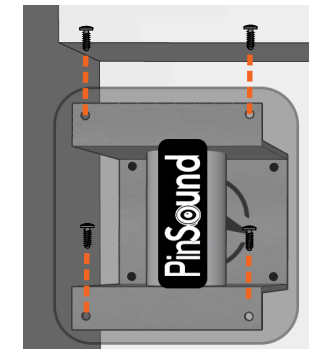

Place the shaker cover and secure it with the 4 screws

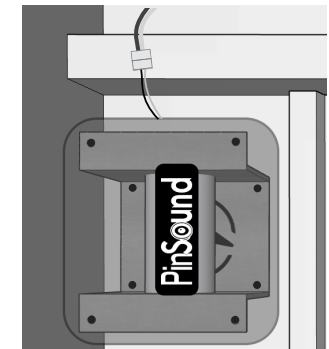

Connect shaker power wire