

PinSound

DATA-EAST CPU EPROM



ps-eprom-toolkit-de



WARNING

The following steps need to be followed carefully. Any failures or consequences are at your own risk and liability. In no case does the warranty cover any damages or indirect damages caused by a careless installation or handling mistake. Please contact a technician if you do not feel confident doing it yourself.



TOOLS

1 OFF

2 OPEN BACKBOX



Extractor

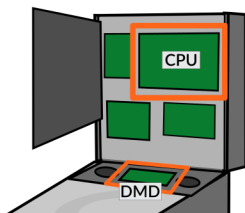
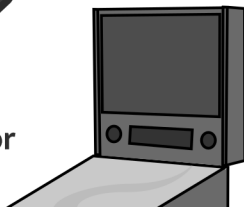

3 LOCATE THE EPROM(S)

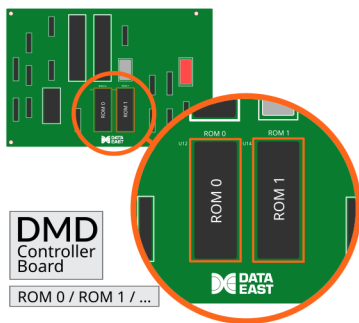
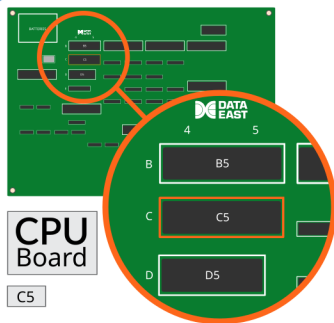

4 EXTRACT ORIGINAL EPROM(S)

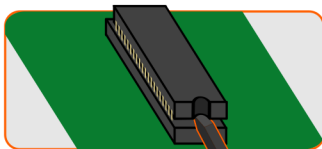

5 INSERT NEW EPROM(S)

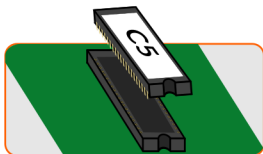

CPU

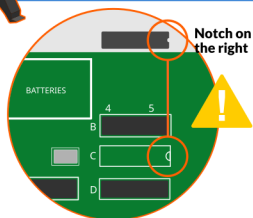

Depending on your game, DMD display ROM upgrade may not be required.



DMD

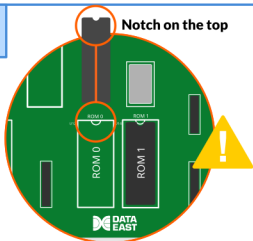

6 MACHINE ON

NEED HELP?

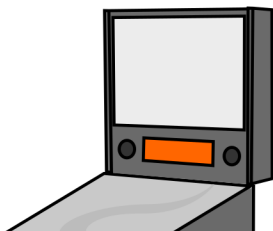

Have fun with
your new game
code!



www.pinsound.org/support