

8 CHECK LED STATUS

Turn your machine ON and check the LEDs status

Full LED status information on www.pinsound.org/support

MotionControl

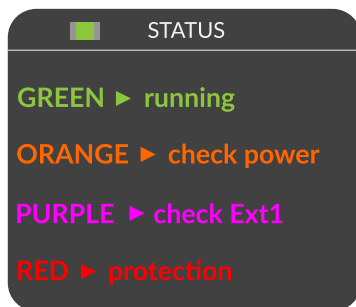

MasterEffect

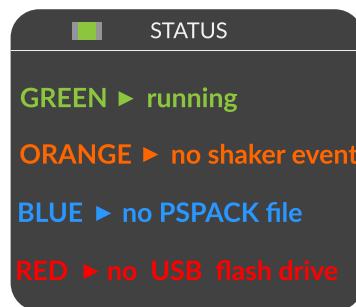

9 OPTIONAL: UPDATE THE MASTER EFFECT

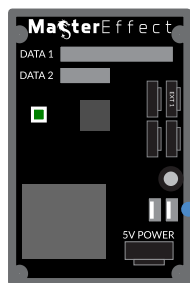

- 1 Update the firmware of your Master Effect board
www.pinsound.org/support
- 2 Download and copy the latest PSPACK file at the root of the flash drive
www.pinsound.org/machine
- 3 Power on the machine, wait for the Master Effect full WHITE led, then cycle your machine's power.

10 ENJOY!

Have fun with your new shaker!

NEED HELP?

Installation video
Firmware update
Guide
Q&A

www.pinsound.org/support



PinSound MotionControl MasterEffect



Standalone shaker kit for WPC-95

KIT CONTENT

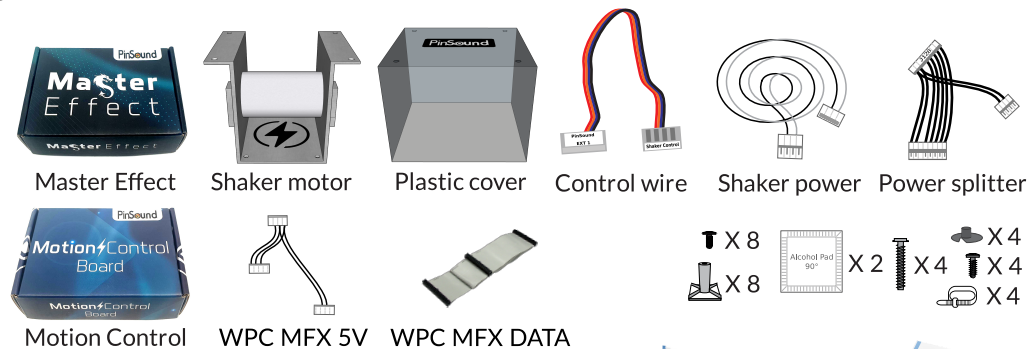

TOOLS



1 LOCATE THE CORRECT SPOT 2 CLEAN THE AREA

⚠ Machine OFF

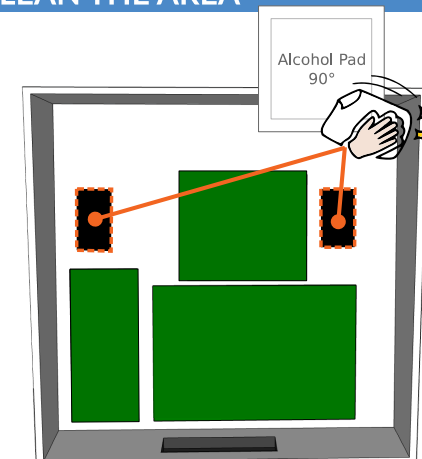
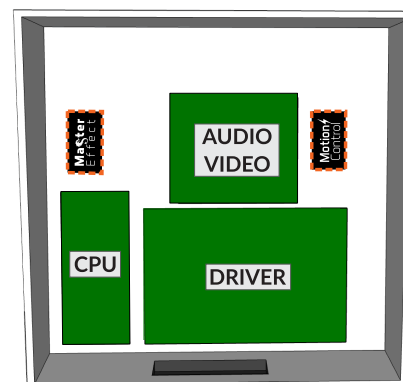

Clean the area with the alcohol pads

3 MOUNT ADHESIVE FEET

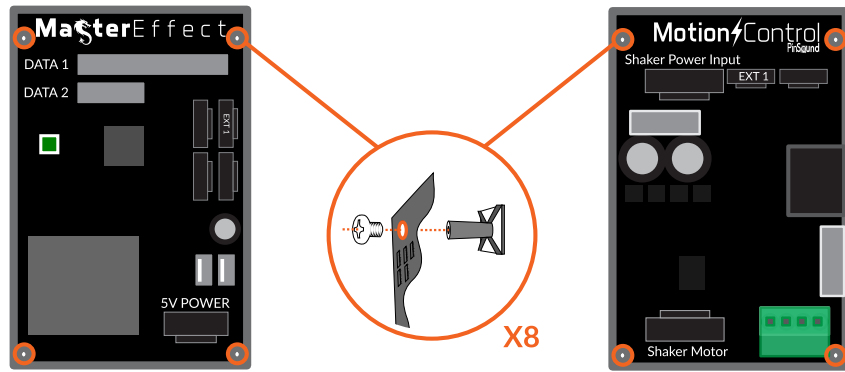

4 STICK THE BOARDS & CONNECT

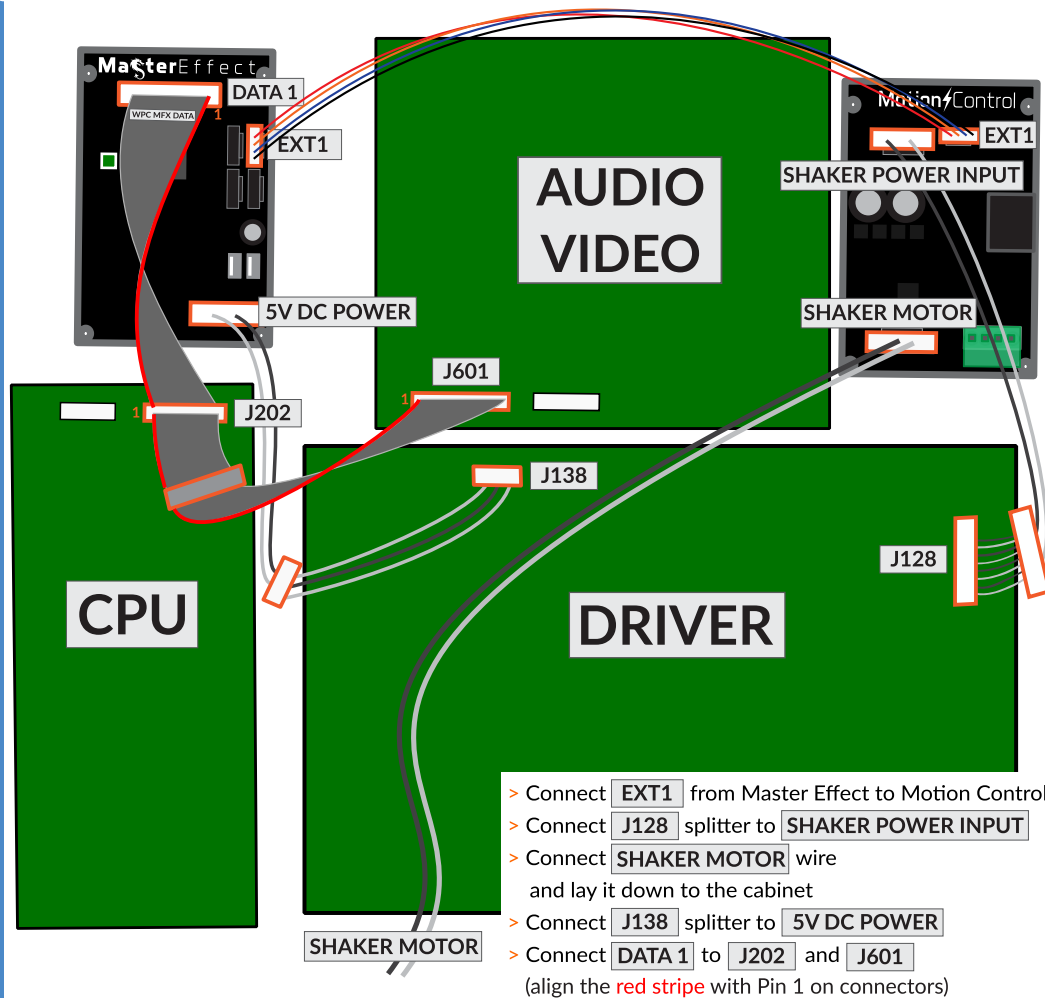

5 PREPARE THE DRILL AND THE TEMPLATE

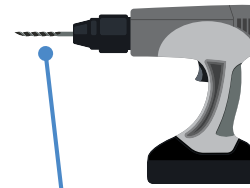

7/32" (5.5mm) drill bit

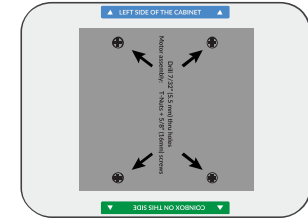

Cut off the WPC drill template

6 PREPARE THE SHAKER FITTING

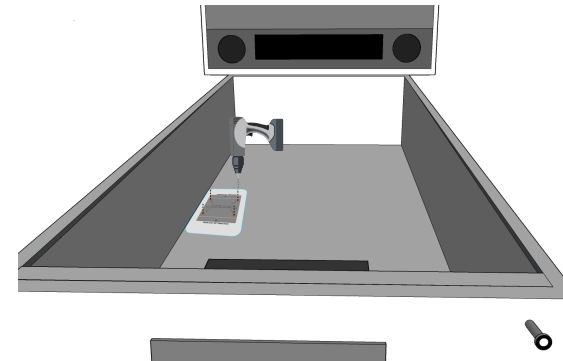

Place the template as indicated and drill the 4 holes

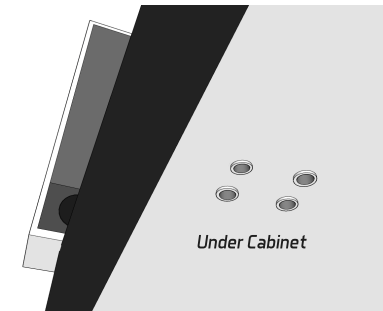

Hammer down the 4 T-Nuts under the cabinet

7 INSTALL THE SHAKER

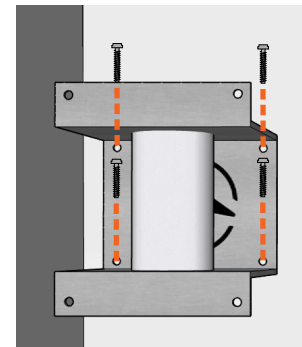

Place the shaker and secure it with the 4 hex screws

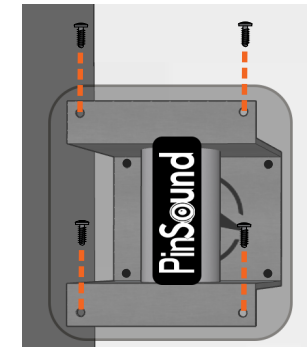

Place the shaker cover and secure it with the 4 phillips screws

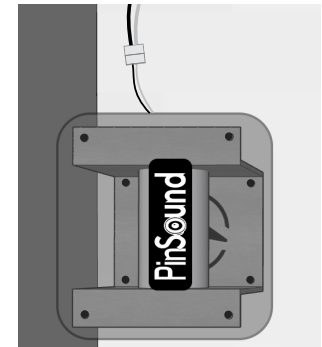

Connect shaker power wire